

Computational Fluid Dynamics Modeling of High Level Waste Plug Formation – 15228

Romani Patel*, Seckin Gokaltun*, Dwayne McDaniel*

* Florida International University

ABSTRACT

At Hanford, an extensive network of pipelines traversing several miles is used to transfer the high level radioactive nuclear waste from tanks to the treatment facilities. During transfer operations, however, there is a potential risk for the transport lines to plug, causing significant delays, increasing operation costs and creating hazardous conditions for personnel and the environment. In this study we investigate the phenomena of plug formation in the pipelines due to solids depositing during the waste transfer process. A three-dimensional (3-D) Computational Fluid Dynamics (CFD) model has been developed using Comsol Multiphysics 4.3b by Florida International University (FIU) to evaluate the factors that can contribute to pipeline plug formation. Several virtual scenarios are developed simulating the settling mechanics as a function of particle size, solids volume fraction and solids density. The numerical results are validated with the available experimental results and the established critical velocity correlations. The 3-D numerical results were also compared with the previous 2-D numerical studies to understand the trade-off between the two studies in terms of computing speed and numerical accuracy.

INTRODUCTION

A vast amount of radioactive waste has been stored at Hanford spanning several decades. A majority of this waste is stored in tanks and is transferred in the slurry form between tanks and from tanks to processing facilities. A waste transfer system consisting of an extensive network of pipelines is used to facilitate the transfer operations. The main goal of the waste transfer system is to transfer the nuclear waste without plugging the transfer pipelines. Currently, two tools have been used to support this objective and include the Environmental Simulation Program (ESP) and empirical based critical velocity correlations. First, ESP is used to estimate the initial waste compositions and solids volume fraction. Then critical velocity correlations are used to estimate the minimum velocity to prevent settling of solids during waste transfers.

Despite such efforts, several lines have plugged during the waste transfer process at Hanford. The plugging has been attributed to two main factors: chemical instability and settling of solids. Chemical instability during waste transfers results in a phase change (from liquid to solid) initiated due to drops in temperature, changes in local concentration or mixing and pumping of wastes that are not in equilibrium. The solid phase precipitates or crystallizes depending on the solubility characteristics of the dissolved multiple species of the waste, their chemical interaction, and temperature. The solids may precipitate out of the solution and accumulate along the pipe walls. The pipe walls then serve as a nucleation site where the solids nucleate and grow rapidly and eventually form an interlocking needle-like crystal network. The needle-like crystal network impedes the flow within the pipe and commences the formation of the plug [1]. The presence of precipitates and/or agglomerates increases the solids concentration and increases viscosity of the slurry. The flow transitions from turbulent to laminar as a result of such changes during transit and the undissolved solids may settle when the flow velocity is not sufficient to keep them suspended. A moving bed of particles then begins to accumulate during slurry transport operation. Settling solids in a moving bed of particles form a stationary bed that eventually fills the pipe and blocks flow.

The blocked pipelines pose several problems at Hanford. The plugged pipelines are considered hazardous,

hard and expensive to repair and cause significant time delays in the clean-up process. Consequently, most plugged transfer pipelines are abandoned. The phenomenon of settling of solids has been the subject of numerous theoretical and experimental studies [2, 3]; however, these require extensive experimental set-ups, procuring varied slurries, and carrying out lengthy experimental trials. The theoretical studies rely heavily on empirical formulae which do not take full account of the settling physics. The settling of solids depends on various physical characteristics of the suspended solids such as particle size, density, flow velocity, volume fraction of solids, etc. A need exists for an inexpensive computational tool that can investigate the influence of various parameters that affect the settling of solids and better aid in understanding the settling dynamics at a click of a button.

A three dimensional (3D) computational analysis has been carried out at FIU simulating settling of solids in a horizontal pipeline as a function of flow velocity, particle size and volume percent solids using the CFD software COMSOL Multiphysics 4.3b. The chemical effects that lead to the settling of solids are not considered for this research study. The numerical results are validated with empirical correlations and experimental results. The outline of the paper is given as follows: First, the governing equations for the mixture model simulations are introduced. Second, simulations modeling settling of solids are presented. Finally, conclusions are drawn and discussions for future work are presented.

NUMERICAL IMPLEMENTATION

The slurry flow in a horizontal pipeline was computed using the mixture model that is part of the Chemical Engineering module of COMSOL Multiphysics 4.3b. The mixture model is a macroscopic two phase model that is able to compute the flow for a mixture of a solid and liquid. It tracks the average phase concentration, or volume fraction and solves for one velocity field for each phase. The two phases consisted of one dispersed phase (solid particles) and one continuous phase (liquid). The model combined the k-epsilon turbulence model for the main flow with equations for the transport of the dispersed phase and the relative velocity of both phases. Some of the assumptions made while using the mixture model are that the density of each phase was constant; that the pressure field was same and the velocity between the two phases could be ascertained from a balance of pressure, gravity, and viscous drag [4].

Governing Equations

The mixture model treats both the continuous as well as the dispersed phase as a single mixture with a slip velocity between them. The momentum equation for the mixture is given by

$$\rho u_t + \rho(u \cdot \nabla)u = -\nabla p - \nabla \cdot \tau_{Gm} + \rho g + F - \nabla \cdot \left[\rho c_d (1 - c_d) \left(u_{slip} - \frac{D_{md}}{(1-c_d)\phi_d} \nabla \phi_d \right) \left(u_{slip} - \frac{D_{md}}{(1-c_d)\phi_d} \nabla \phi_d \right) \right] \quad (1)$$

where, u denotes mixture velocity (m/s), ρ is the mixture density (kg/m^3), p is the pressure (Pa), c_d is the mass fraction of the dispersed phase (kg/kg), u_{slip} is the relative velocity between the two phases (m/s), τ_{Gm} is the sum of viscous and turbulent stress ($\text{kg}/(\text{m}\cdot\text{s}^2)$), g is the gravity vector (m/s^2), and F is the additional volume forces (N/m^3).

The velocity u used here is the mixture velocity which is defined as

$$u = \frac{\phi_c \rho_c u_c + \phi_d \rho_d u_d}{\rho} \quad (2)$$

Here, c and d denote the volume fractions of the continuous phase and the dispersed phase (m^3/m^3), respectively, u_c is the continuous phase velocity (m/s), u_d is the dispersed phase velocity (m/s), ρ_c is the continuous phase density (kg/m^3), ρ_d is the dispersed phase density (kg/m^3), and ρ is the mixture density (kg/m^3).

The relationship between the velocities of the two phases is defined by

$$u_d - u_c = u_{cd} = u_{slip} - \frac{D_{md}}{(1-c_d)\phi_d} \nabla \phi_d \quad (3)$$

Here, u_{slip} (m/s) denotes the slip velocity between the two phases, and D_{md} is a turbulent dispersion coefficient (m^2/s) accounting for extra diffusion due to turbulent eddies.

The Schiller-Neumann model was used to compute the slip velocity which uses the following relation,

$$\frac{3}{4} \frac{C_d}{d_d} \rho_c |\mu_{slip}| \mu_{slip} = \frac{(\rho - \rho_d)}{\rho} \nabla p \quad (4)$$

where, C_d is the dimensionless particle drag coefficient and is defined as

$$C_d = \frac{24}{Re} (1 + 0.15 Re^{0.687}), Re \leq 1000 \quad (5)$$

and

$$C_d = 0.44, Re \geq 1000 \quad (6)$$

The mixture density ρ is given by

$$\rho = \phi_c \rho_c + \phi_d \rho_d \quad (7)$$

where ρ_c and ρ_d (kg/m^3) are the densities of each of the two phases.

The mass fraction of the dispersed phase c_d is given by

$$c_d = \frac{\phi_d \rho_d}{\rho} \quad (8)$$

The sum of viscous and turbulent stress is

$$\tau_{Gm} = (\mu + \mu_T) [\nabla u + \nabla u^T] \quad (9)$$

where, μ ($\text{Pa}\cdot\text{s}$) is the mixture viscosity and μ_T ($\text{Pa}\cdot\text{s}$) the turbulent viscosity.

The transport equation for ϕ_d , the dispersed phase volume fraction, is

$$\frac{\partial}{\partial t} (\phi_d \rho_d) + \nabla \cdot (\phi_d \rho_d u_d) = -m_{dc} \quad (10)$$

where, m_{dc} ($\text{kg}/(\text{m}^3\cdot\text{s})$) is the mass transfer rate from dispersed to continuous phase and u_d (m/s) is the dispersed phase velocity according to Eq. (3).

Assuming constant density for the dispersed phase Eq. (7) is rewritten as,

$$\frac{\partial}{\partial t}(\phi_d) + \nabla \cdot (\phi_d \mathbf{u}_d) = -\frac{m_{dc}}{\rho_d} \quad (11)$$

The continuous phase volume fraction, ϕ_c , is

$$\phi_c = 1 - \phi_d \quad (12)$$

and the continuity equation for the mixture is given as

$$\rho_t + \nabla \cdot (\rho \mathbf{u}) = 0 \quad (13)$$

The Mixture Model interfaces assumes that the densities of each phase, ρ_c and ρ_d are constant, and therefore uses the following alternative form of the continuity equation of the mixture,

$$(\rho_c - \rho_d) \left[\nabla \cdot (1 - c_d) \mathbf{u}_{slip} - D_{md} \nabla \phi_d \right] + \frac{m_{dc}}{\rho_d} + \rho_c (\nabla \cdot \mathbf{u}) = 0 \quad (14)$$

The flow turbulence is modeled using the k- ε turbulence model which solves two extra transport equations for the turbulent kinetic energy, k and the dissipation rate of turbulent kinetic energy, ε as described below. The turbulent viscosity is given by

$$\eta_T = \rho C_\mu \frac{k^2}{\varepsilon} \quad (15)$$

where, C_μ is a model constant and is equal to 0.09.

The transport equation for the turbulent kinetic energy k is

$$\rho \frac{\partial k}{\partial t} + \rho \mu \cdot \nabla k = \nabla \cdot \left(\left(\mu + \frac{\mu_T}{\sigma_k} \right) \cdot \nabla k \right) + P_k - \rho \varepsilon \quad (16)$$

where the production term is

$$P_k = \mu_T (\nabla \mu : (\nabla \mu + (\nabla \mu)^T)) - \frac{2}{3} (\nabla \cdot \mu)^2 - \frac{2}{3} \rho k \nabla \cdot \mu \quad (17)$$

The turbulent kinetic energy, ε , is determined by

$$\rho \frac{\partial \varepsilon}{\partial t} + \rho \mu \cdot \nabla \varepsilon = \nabla \cdot \left(\left(\mu + \frac{\mu_T}{\sigma_\varepsilon} \right) \cdot \nabla \varepsilon \right) + C_{\varepsilon 1} \frac{\varepsilon}{k} P_k - C_{\varepsilon 2} \rho \frac{\varepsilon^2}{k} \quad (18)$$

where, $C_{\varepsilon 1}$, $C_{\varepsilon 2}$, σ_k , and σ_ε , are model constant and the values used were 1.44, 1.92, 1 and 1.3, respectively.

Model Geometry and Boundary Conditions

The model geometry for the simulations consisted of a three dimensional (3D) horizontal pipe with a diameter of 0.078 m and a length of 5.2 m. The slurry was modeled as a Newtonian suspension consisting of solids particles dispersed in liquid. The mixture entered through the inlet at velocities characterizing fully developed turbulent flow regimes. The turbulence intensity and length scale were set to 5% and $0.07 \cdot r_{in}$ where $r_{in} = 0.039$ is the radius of the inlet. The solids were modeled as spherical solid particles of equal size with the particle size ranging from 14.4-220 μm . The solid volume fraction ranged from 2.9-9.8%. The solid densities ranged from 1000-8000 kg/m^3 and the liquid densities ranged from 999-1647 kg/m^3 . The outlet was set to zero pressure, no viscous stress and the dispersed phase flow exited the pipe at mixture velocity. A gravity node was added to account for the gravity force in the negative

y-direction over the entire domain. Initially, the velocity as well as the solids phase volume fraction was zero in the entire model domain. The mesh used to partition the model domain into sub-domains consisted of triangular elements as shown in Fig. 1.

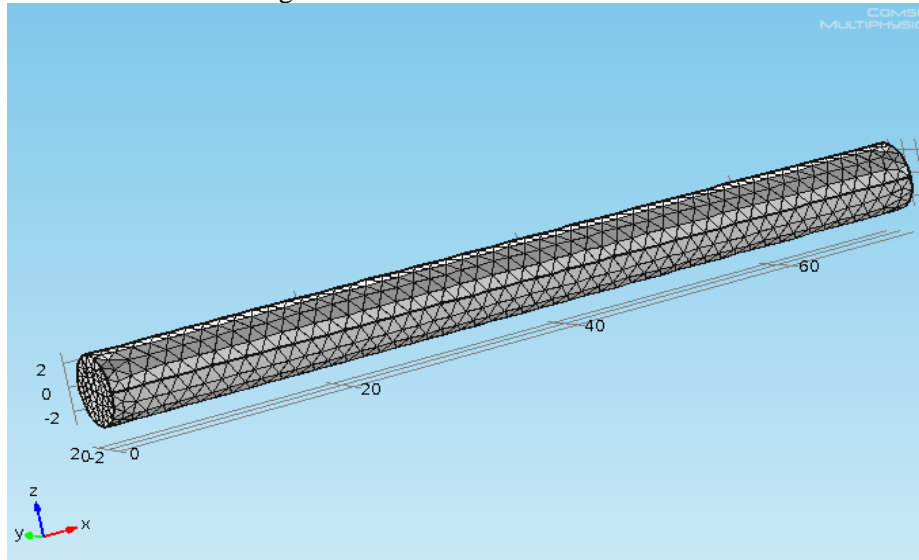

Fig. 1. Model geometry and boundary conditions for the mixture model simulations.

Numerical Simulations

A. PNNL Comparison

The mixture model to simulate settling of solids is solved via a transient simulation. TABLE I below lists the material properties used for the numerical simulations.

TABLE I. Numerical Simulations Matrix-PNNL Comparison

Test Configuration	Model Verification Study				
	1	2	3	4	5
Particle diameter (μm)	14.4	37.7	129.5	182.3	203.9
Solids Density (kg/m^3)	2500	7950	3770	2500	7950
Solids volume fraction (%)	9.8	9.3	8.7	7.4	3.0
Liquid density (kg/m^3)	1146	1647	1151	999	1026
Liquid viscosity (cP)	10.2	9.3	4.5	1.5	1.6

The material properties were obtained from the experimental tests done by Pacific Northwest National Laboratory (PNNL) to determine the critical velocity for Newtonian slurries. The critical velocity obtained by the numerical simulations was compared with the experimental results of PNNL and with the empirical based critical velocity correlations. The 3-D numerical results were also compared with the

previous 2-D numerical studies to understand the trade-off between the two studies in terms of computing speed and numerical accuracy.

The numerical results were a good match with the experimental results and demonstrated the use of COMSOL Multiphysics 4.3b to accurately simulate the settling physics as shown in Fig. 2. Moreover, there was little variance observed between the computed 2-D critical velocity results to those compared with the 3-D results. The 3-D models had relatively longer computing time (> 24 hr) compared to the couple of hours it took for the 2-D models to solve. Hence it was concluded that the 2-D models were a good enough representation and highly accurate of the settling behaviors simulated with the given material properties and future studies would not require 3-D representation.

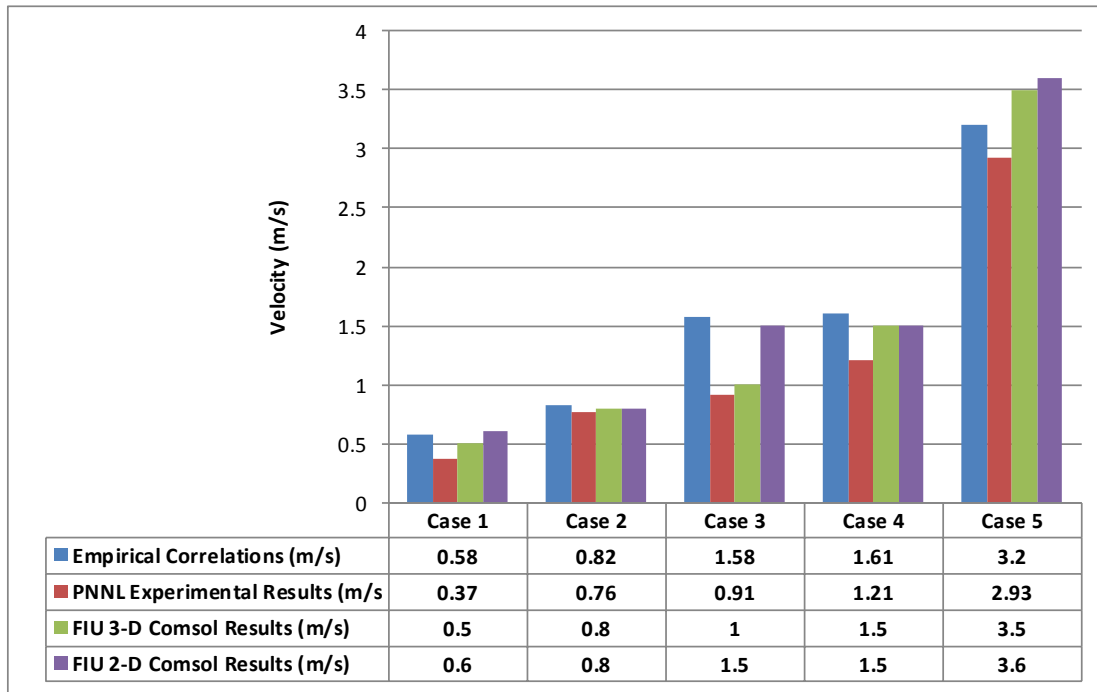

Fig. 2. Comparison of numerical results to experimental and empirical results.

The main problem with using the critical velocity correlations to determine the velocity of the transfer operations is that the equation is based on single component density particles forming narrowband PSD. The use of the equation for multi-component density particles, broadband PSDs, and/or median particle sizes less than 100 μm (typical Hanford waste) requires extrapolation beyond the database used in the development of equation. Hence, the equation should be used with caution when applied for any of these conditions. Moreover, the PSD is assumed to be static while deriving these correlations. But in actual waste transfers, the PSD is dynamic due to precipitation, particle agglomeration, and particle-surface interactions. The correlations do not provide information about the solids volume fraction, temperature, local velocity profile, PSD, etc along the length of the pipe nor any information on how these quantities change with time. The correlation is applicable for calculating the critical velocity of Newtonian fluids in straight, horizontal piping. When applied to non-Newtonian fluids in horizontal piping, these correlations under-predict the critical velocities [3]. Moreover, the transfer lines consists of vertical segments, pipe bends, Tee's, reducers, jumpers, connector and various other pipe components which can affect the critical velocity and plug formation process and the empirical formulae does not consider such complex piping components. Hence, future studies will include investigating the influence of pipeline components

on the settling mechanics.

Additional virtual scenarios were also simulated to understand the behavior of settling as a function of flow velocity by varying particle size, solids density and solids volume fraction. The material properties used for each of these studies is described in their corresponding sections along with a brief analysis of the results observed.

B. Influence of Particle Size

The effect of particle size on the settling dynamics was investigated using 45 μm and 220 μm size solids particles dispersed in water. The solids density was kept constant at 3147 kg/m^3 and the liquid density used was 1000 kg/m^3 . The solids volume fraction was 2.9%. The simulations were carried out with entrance velocities ranging from 0.8 m/s to 2 m/s. The 45 μm and 220 μm particle concentrations at different velocities are shown in Fig. 3 and Fig. 4. The color legend represents the different solids concentration in the pipe.

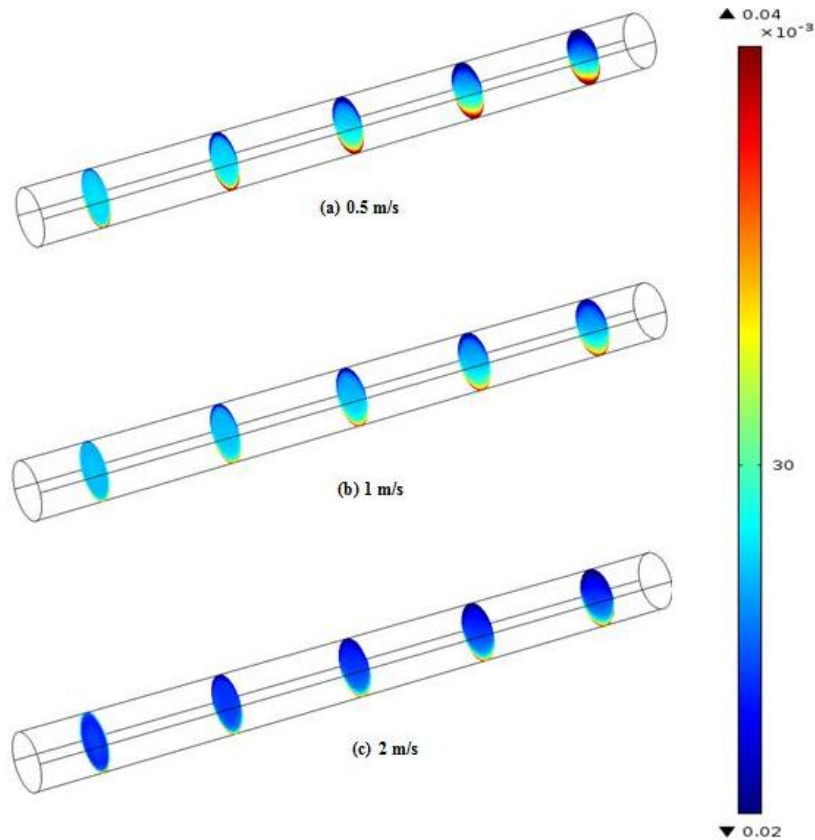

Fig. 3. A 45 μm particle concentration along the pipe as a function of flow velocity ranging from 0.8 to 2 m/s

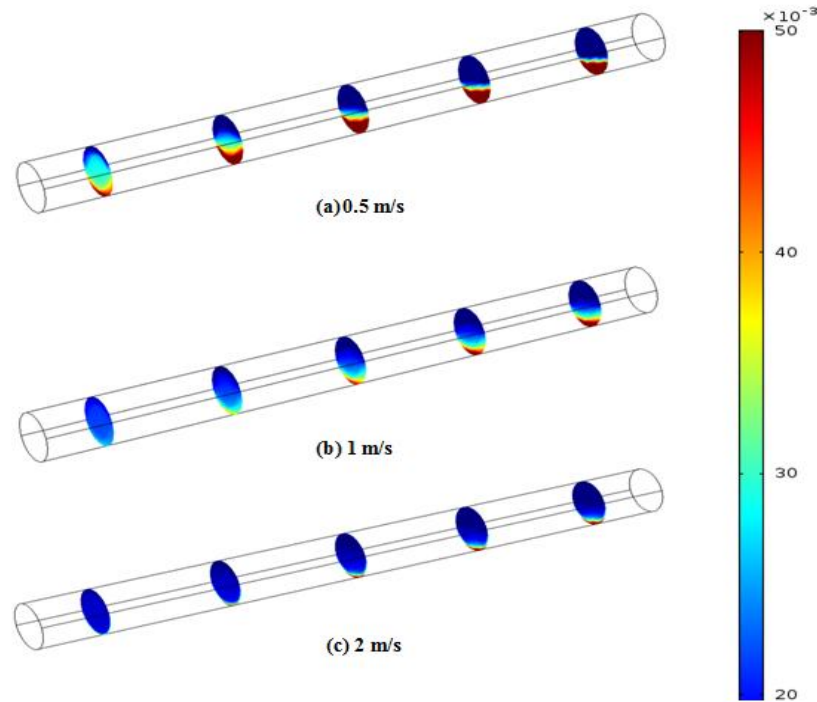

Fig. 4. A 200 μm particle concentration along the pipe as a function of flow velocity ranging from 0.5 to 2 m/s

The concentrations figures show that the 220 μm larger and heavier particles tend to settle fast on the bottom of the pipe, especially at low flow velocities. The simulations showed that flow velocities of lower than 1.0 m/s will create a stationary bed flow that eventually causes a plug to form. For velocities of greater than 1.0 m/s, the fluid establishes a moving bed regime where the particles move along the bottom of the transfer pipe.

C. Influence of Solids Density

The effect of solids density on the settling dynamics was investigated by running simulations for the 45 μm particle size and 2.9% solids volume fraction at solids densities of 3147 kg/m^3 and 6300 kg/m^3 . The entrance velocities used were 0.5 m/s, 1 m/s and 2 m/s. The results of the simulations are shown in Fig. 5, Fig. 6 and Fig. 7 respectively.

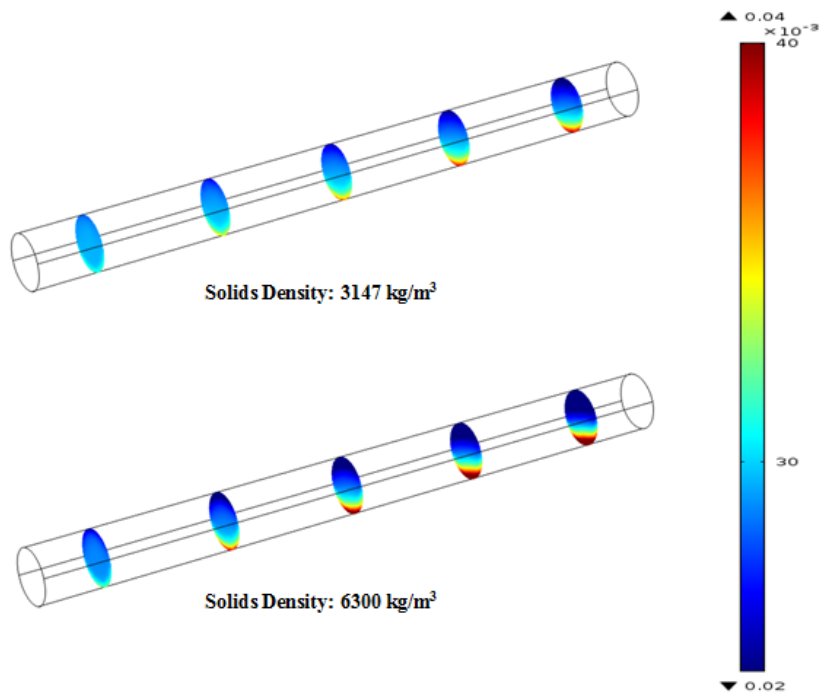

Fig. 5. Settling of solids as a function of solids density for 45 μm particles at 0.5 m/s

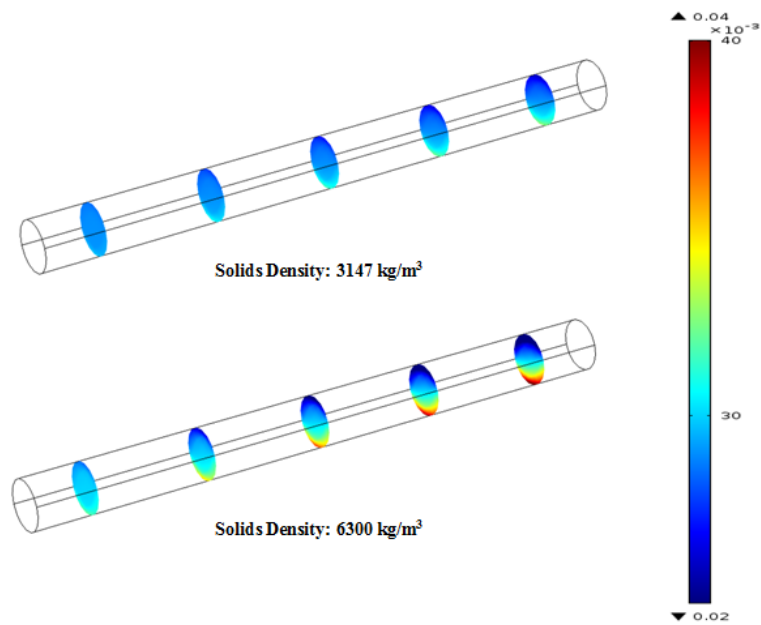

Fig. 6. Settling of solids as a function of solids density for 45 μm particles at 1 m/s

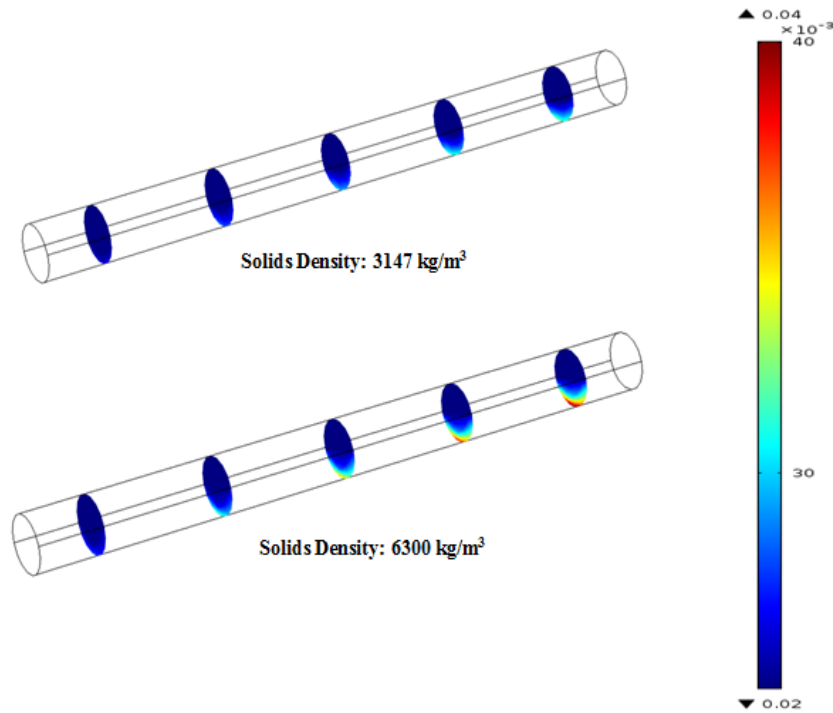

Fig. 7. Settling of solids as a function of solids density for 45 μm particles at 2 m/s

The higher density slurries require a higher velocity to keep them suspended and prevent them from settling at the bottom compared to the lower density slurries. The critical velocity for the slurries with density of 3147 kg/m^3 was 0.7 m/s compared to the 4 m/s velocity obtained for the heavier slurries with density of 6300 kg/m^3 .

D. Influence of Solids Volume Fraction

The effect of solids volume fraction on the critical velocity was investigated by running simulations for $45 \mu\text{m}$ particles with a solids density of 3147 kg/m^3 . The solids volume fraction values ranged 2.9%, 5.8% and 10% respectively. The liquid density was fixed at 1000 kg/m^3 . The critical velocities were calculated for each case and were numerically assessed as the velocity at which the solids were fully suspended in liquid and hence no settling was observed at the bottom of the pipe. For example, for the slurry consisting of 2.9% volume fraction of solids, the solids were observed to settle at 0.5 m/s, 0.8 m/s, and 1 m/s. This can be seen as an increase in the solids volume fraction from the initial 2.9% to 3.53%, 3.35% and 3.27% at the respective velocities. As the velocity was further increased to 2 m/s, the solids do not settle. They remain fully dispersed across the pipe length as the solids volume fraction stays the same as the initial volume fraction value, i.e. 2.9%. Any increase in the velocity thereafter shows that the solids remain fully suspended. Hence the critical velocity calculated for the case with solids volume fraction of 2.9% is 2 m/s. TABLE II below shows the solids volume fraction values highlighted in red color for the cases simulated and their corresponding measured critical velocities.

TABLE II. Flow Velocity as Function of Solids Volume Fraction

Flow Velocity (m/s)	Solids volume fraction 2.9%	Solids volume fraction 5.8%	Solids volume fraction 10%
0.5	3.53%	6.84%	11.32%
0.8	3.35%	6.57%	10.98%
1	3.27%	6.42%	10.80%
2	2.90%	6.13%	10.44%
4	2.90%	5.90%	10.20%
6	2.90%	5.90%	10.12%

As the solids volume fraction increases, the critical velocity increases, as expected. For instance, the slurry with solids volume fraction of 2.9% the critical velocity obtained is 2 m/s compared to the 4 m/s obtained for solids volume fraction of 5.8% and 6 m/s for the slurry with solids volume fraction of 10%.

CONCLUSION AND FUTURE WORK

In this paper, the implementation of COMSOL Multiphysics 4.3b has been presented simulating settling of solids as a function of flow velocity, particle size, solids density and solids volume fraction. The 3-D numerical results compared very well with the experimental results and empirical correlations as well as prior 2D numerical studies. There was very little variance observed between the computed 2-D critical velocity results and the 3-D results. The 3-D models had relatively longer computing time (> 24 hr) compared to the couple of hours it took for the 2-D models to solve. Hence it was concluded that the 2-D models were a good enough representation of the settling behaviors simulated with the given material properties and future studies would not require 3-D representation. The empirical formula widely used is applicable for calculating the critical velocity of Newtonian fluids in straight, horizontal piping. When applied to non-Newtonian fluids in horizontal piping, these correlations under-predict the critical velocities [3]. Moreover, the transfer lines consists of vertical segments, pipe bends, Tee's, reducers, jumpers, connector and various other pipe components which can affect the critical velocity and plug formation process and the empirical formulae does not consider such complex piping components. Hence future work would include developing virtual models representing non-Newtonian fluids transporting through complex piping layouts and pipeline components to help in understanding their influence on the settling mechanics.

REFERENCES

1. Servin, M.A. et al., "Feasibility Study of Pressure Pulsing Pipeline Unplugging Technologies for Hanford", Washington River Protection Solution, LLC, Richland, Washington (2012).
2. Bae K.S. et al., "Empirical Correlation for the Minimum Transport Velocity of Multidisperse Slurries in Horizontal Pipes", Korean Journal of Chemical Engineering 8(2):120–124 (1991).

3. Poloski, A. P. et al., “Deposition Velocities of Newtonian and Non-Newtonian Slurries in Pipelines”, PNNL-17639, WTP-RPT-175, Rev-0, Pacific Northwest National Laboratory, Richland, Washington (2009).
4. www.comsol.com.