

**The Effect of the Presence of Ozone on the Lower Flammability Limit (LFL) of Hydrogen
in Vessels Containing Savannah River Site High Level Waste -12387**

Carol Sherburne
Savannah River Remediation, LLC
Savannah River Site, Aiken, SC

Paul Osterberg
Fauske and Associates, LLC
Burr Ridge, Illinois

ABSTRACT

The Enhanced Chemical Cleaning (ECC) process uses ozone to effect the oxidation of metal oxalates produced during the dissolution of sludge in the Savannah River Site (SRS) waste tanks. The ozone reacts with the metal oxalates to form metal oxide and hydroxide precipitants, and the CO₂, O₂, H₂O and any unreacted O₃ gases are discharged into the vapor space. In addition to the non-radioactive metals in the waste, however, the SRS radioactive waste also contains a variety of radionuclides, hence, hydrogen gas is also present in the vapor space of the ECC system. Because hydrogen is flammable, the impact of this resultant gas stream on the Lower Flammability Limit (LFL) of hydrogen must be understood for all possible operating scenarios of both normal and off-normal situations, with particular emphasis at the elevated temperatures and pressures of the typical ECC operating conditions. Oxygen is a known accelerant in combustion reactions, but while there are data associated with the behavior of hydrogen/oxygen environments, recent, relevant studies addressing the effect of ozone on the flammability limit of hydrogen proved scarce. Further, discussions with industry experts verified the absence of data in this area and indicated that laboratory testing, specific to defined operating parameters, was needed to comprehensively address the issue. Testing was thus designed and commissioned to provide the data necessary to support safety related considerations for the ECC process. A test matrix was developed to envelope the bounding conditions considered credible during ECC processing. Each test consists of combining a gas stream of high purity hydrogen with a gas stream comprised of a specified mixture of ozone and oxygen in a temperature and pressure regulated chamber such that the relative compositions of the two streams are controlled. The gases are then stirred to obtain a homogeneous mixture and ignition attempted by applying 10J of energy to a fuse wire. A gas combination is considered flammable when a pressure rise of 7% of the initial absolute pressure is observed. The specified testing methodology is consistent with guidelines established in ASTM E-918-83 (2005) "Standard Practices for Determining Limits of Flammability of Chemicals at Elevated Temperature and Pressure".

INTRODUCTION:

A simplified depiction of the ECC process is shown in Figure 1, below.

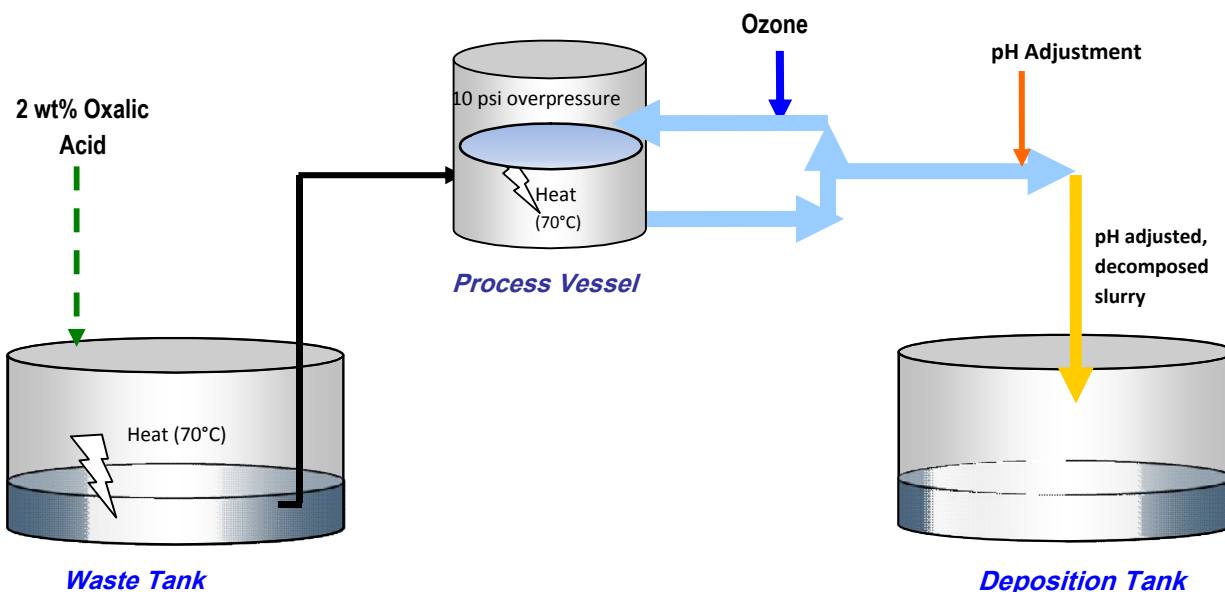

Figure 1: Schematic of the Enhanced Chemical Cleaning Process

The SRS waste tanks are carbon steel vessels, each approximately 4 million liters in volume. The 51 tanks, with various minor modifications in size, design and materials of construction, have been used since the 1950s to collect the high level nuclear waste generated as part of the national defense effort that supplied nuclear material for weapons, medicine, NASA and nuclear research campaigns. Currently, in support of the Federal Facilities Agreement Act, the tanks are being emptied, cleaned and grouted; and the waste permanently dispositioned in a series of specialized treatment processes. To date, of the original inventory of 400 million curies of radioactivity, approximately 40 million curies have been removed from the tanks. Most waste tanks have/had 3 distinct physical phases, a high pH supernatant top layer, a solid salt layer and a "sludge" layer (approximately 30 volume % solids in 70 volume % liquid). The solids are mainly metal hydroxides and oxides of radionuclides, primarily isotopes of plutonium and uranium, in addition to sodium, iron and aluminum. In general, the majority of the waste removal is accomplished by a Bulk Waste Removal (BWR) campaign which empties the tank of easily accessible liquid supernatant and other liquid, followed by salt dissolution/removal and, finally, heel removal. At the end of the BWR campaign, fewer than 20,000 liters of sludge (less than 2 inches depth) remain in the tank. Currently, this final residual material is cleaned from the tank during a process called Bulk Oxalic Acid Cleaning (BOAC), whereby heated, 6 weight

percent oxalic acid is added to the tank to a sufficient level to enable mixing. The solution is then vigorously mixed, encouraging soluble material to be dissolved into solution and the insoluble material to be entrained in the rapidly moving fluid. The resulting slurry is transferred out, usually in a 3 strike campaign, to a receipt tank where it is neutralized prior to further processing. While BOAC has been effective in sludge dissolution and removal, the metal oxalates formed during oxalic acid dissolution cause downstream complications (e.g. foaming and fouling of the post-ECC Tank Farm evaporator). Further, the sodium oxalate salt formed during corrosion mitigating pH adjustment must be washed from the sludge to meet feed qualifications of the Defense Waste Processing Facility. As sodium oxalate exhibits limited solubility in aqueous solutions, copious quantities of wash volume are thus necessary, greatly increasing the burden on the Saltstone Disposal Facility and, subsequently, the demand for disposal vaults. This prompted research, testing and acceptance of a treatment process that utilized the proven effectiveness of oxalic acid for sludge dissolution and mobilization, yet removed the offending metal oxalates from the solution without adding liquid volume or contaminants. The Enhanced Chemical Cleaning (ECC) process was thus developed to replace the BOAC stage of waste removal.

After Bulk Waste Removal but prior to undergoing the ECC process, the residual sludge material inside the tanks will be washed with water to remove most of the remaining soluble materials and sodium hydroxide, then emptied to approximately 20,000 liters. The ECC process then begins with the addition of roughly 500,000 liters of 2 wt% oxalic acid to the tanks as the solution is recirculated and heated to a temperature of 70°C. Batches of dissolved sludge, 8,000 liters each, are then transferred to the ECC process vessel. After several batches are removed from the waste tank, additional oxalic acid is added in a series of decants/refreshes in order to maximize the dissolution/removal of the sludge from the tanks.

The major chemistry employed in the ECC process vessel is the reaction of ozone with the metal oxalates to form metal oxides, metal hydroxides, CO₂ and H₂O by the reactions shown below:

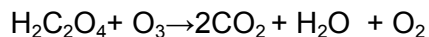
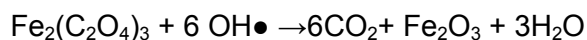
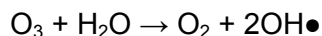

While only the Iron oxalate reaction is listed above, formation of the powerfully reactive hydroxyl radical initiates many oxidizing reactions, effectively putting most waste constituents into their highest oxidation state.

The ozone is produced using a corona discharge ozone generator, fed from a pressure swing absorption molecular sieve oxygen concentrator. The ozone generator produces a gas stream containing 7 volume % ozone, 87 vol % oxygen, and the remainder air and water vapor. The gas stream is fed at a rate of 1700 liters per min into an eductor. The waste solution is pumped through the eductor at approximately 10,000 liters per minute. The vacuum produced by the solution moving through the eductor provides the motive force to pull the gaseous ozone into

waste stream. The process is held at 70°C to improve decomposition kinetics and 10 psi overpressure to improve ozone solubility. It has been calculated and demonstrated that an ozone solubility of roughly 25 ppm can be attained at these conditions.

While ozone is a strong oxidizer and most is expected to decompose by reacting with the waste constituents, some ozone will remain unreacted as it exits the liquid and enters the ECC vessel vapor space, particularly at the end of each ECC batch cycle. During processing, the vapor space will also contain the reaction products CO₂, O₂ and H₂O from the reactions previously described. In addition, however, as ionizing radiation decomposes the water inherent in the waste to atomic hydrogen and oxygen, radiolytically produced hydrogen will be present as well. As the behavior of hydrogen with regard to flammability in air is well understood, mechanisms are designed into all areas of SRS waste handling to appropriately address this safety issue. The unique concern for ECC, however, is that while CO₂, O₂ and H₂O can act as diluents, reducing the concentration of hydrogen in the vapor space, it is not known how hydrogen behaves in the presence of ozone and, thus, whether current guidelines to maintaining the vapor space environment within safe margins are adequate. Further, during shutdown conditions, it is possible that hydrogen could be generated into an atmosphere containing residual ozone. In the absence of applicable literature, testing is thus necessary to provide data relative to the behavior of ozone with hydrogen under normal and credible off normal ECC conditions so that reaction mechanisms can be understood and relevant design and operating parameters be appropriately considered and applied. Fauske and Associates, LLC, a company of established experts in flammability testing, was commissioned to perform the testing.

METHOD

Test Conditions:

A test matrix was developed at multiple concentrations of ozone and hydrogen such that the results are statistically valid while minimizing the number of tests to be performed. The test matrix is shown as Table I below.

Table I: Test Conditions for Testing the Lower Flammability Limit of Specified Gas Mixtures

Test ID	H ₂ (Vol. fraction)	O ₂ (Vol. fraction)	O ₃ (Vol. fraction)	N ₂ (Vol. fraction)	Pressure (psia)	Temp (°C)
1	V	0.21B	0.00	0.79B	14.7	25
2	V	0.99B	0.01B	trace	14.7	25
3	V	0.98B	0.02B	trace	14.7	25
4	V	0.97B	0.03B	trace	14.7	25
5	V	0.96B	0.04B	trace	14.7	25
6	V	0.95B	0.05B	trace	14.7	25
7	V	0.94B	0.06B	trace	14.7	25
8	V	0.93B	0.07B	trace	14.7	25

9	V	0.92B	0.08B	trace	14.7	25
10	0	B	V	0.00	14.7	25
11	V	0.95B	0.05B	0.00	24.7	25
12	V	0.95B	0.05B	0.00	14.7	75
13	V	0.093B (nominal)	0.007B (nominal)	0.9B	14.7	25

Where V represents *Variable* and B represents *Balance*. Using the equation $V+B=1$, the actual test concentrations can be determined. For example, Test 6 begins with stream “B” that is 95% oxygen/5% ozone. Stream “V”, hydrogen gas, is added in a series of trials increasing in proportion of stream V to B, (i.e. 1% stream V/99% stream B, 2% stream V/98% stream B, etc) until deflagration is achieved. For this case, deflagration was achieved at 97% stream B to 3% stream V. This translates to an overall gas composition of 92.2% oxygen, 4.8% ozone, and 3% hydrogen, as shown in Figure 3.

The first test on the test matrix, Test ID 1, was requested to establish a baseline for the test setup. There is ample evidence in literature to indicate that the Lower Flammability Limit (LFL) of hydrogen in air at standard temperature and pressure (STP) is a nominal 4% by volume [1]. Because this determination can be affected by many parameters including: test vessel geometry, ignition energy, ignition type, feed gas purity, ambient conditions and others, it was important to establish the LFL of hydrogen in air using this test setup and test procedures so that appropriate comparisons to established norms can be made.

Test IDs 2-9 consist of combining a gas stream of high purity hydrogen with a gas stream comprised of a specified mixture of ozone and oxygen. The intent was to not only establish single flammability points corresponding to several distinct operating conditions but also provide predictive data so that an envelope of conditions could be encompassed.

Test ID 10 was requested to corroborate data in literature [2] that suggest that the decomposition of ozone at relatively high concentrations can produce a pressure rise consistent with the definition of a flammable mixture. Further, as ozone is known to produce a visible flame at certain conditions, it was important to isolate ozone in an oxidation environment and determine its combustion characteristics when ozone is the sole fuel component.

Increases in temperature and pressure generally result in widening of the flammable region. With only small increases in temperature and pressure, these effects are typically minute on the lower flammable limit and may be considered negligible. As a result, the testing was designed at STP conditions. However, the actual impact of these conditions is assessed in Test ID 11 and 12.

Test ID 11 is designed to determine the LFL of hydrogen in the 10 psi overpressure condition of the ECC process vessel at nominal ECC vapor space ozone concentrations. This test replicates the gas concentrations of Test 6, but at the operating pressure expected during normal ECC operation. Comparison to Test 6 results gives an indication of the effect of elevated pressure on the LFL.

Test ID 12 is designed to determine the effect of elevated temperature on the LFL of hydrogen at nominal ECC vapor space ozone concentrations. This test replicates the gas concentrations

of Test 6, but at the operating temperature expected during normal ECC operation. Comparison to Test 6 results gives an indication of the effect of elevated temperature on the LFL.

Test ID 13 is designed to replicate a scenario where an ozone/oxygen mixture is introduced into an air/hydrogen environment.

Flammability Apparatus:

In order to ensure consistency between this testing and other documented flammability testing, the test methodology utilizes the guidelines established in ASTM E-918-83 (2005) "Standard Practices for Determining Limits of Flammability of Chemicals at Elevated Temperature and Pressure" [3]. Using this standard as the testing basis, a test setup was developed and is given in Figure 2.

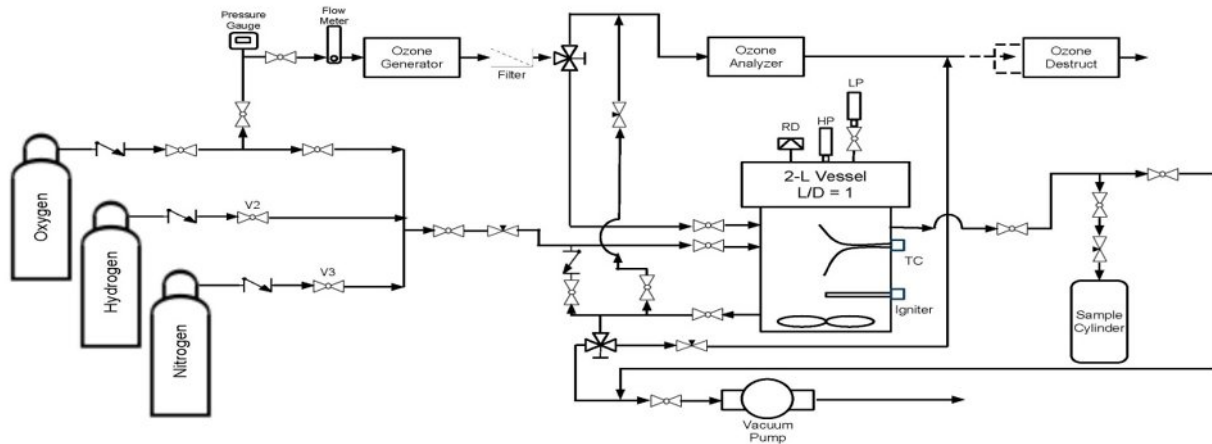

Figure 2: Test Apparatus for Testing the Lower Flammability Limit of Specified Gas Mixtures

The testing was conducted in a 2-L vessel rated to 3,000 psi at 500°C with an L/D ratio of one. There are two pressure transducers mounted on the vessel: a high accuracy (0.05% full scale) low range pressure transducer (0-25 psia) used for preparing the gas mixtures by partial pressure and a high accuracy (0.05% full scale) high range pressure transducer (0-200 psia) used to monitor the pressure after the mixture is ignited. High purity research grade gases were used for the preparation of the gas mixtures: nitrogen (99.9999%), oxygen (99.999%), and hydrogen (99.9999%). Two thermocouples were placed in the vessel to measure the temperature at the center and at the upper area of the vessel. A stir bar was placed at the bottom of the vessel to provide mixing of the gases. The gas mixture was ignited using an exploding fuse wire positioned a third of the way from the bottom. The energy provided by the fuse wire was approximately 10 joules. An ignition energy of 10 J was chosen because it produces very little wire spatter and a cylindrical shock wave is formed upon the vaporization of the wire because it is above 5 J/cm [4].

Ozone is generated on-site using a high ozone concentration generator. The ozone concentration of the ozone/oxygen stream is analyzed with an in-line UV absorption unit

designed to enable accurate measurements of ozone from 0.01 wt. % ozone in oxygen to 20 wt. %.

In order to minimize undesired ozone decomposition, the materials used for this testing were carefully chosen. The test vessel, tubing, and fittings are all made of 316 stainless steel and passivated per ASTM A967. The packing material and/or seals for the valves were made of PTFE or fluorocarbon FKM.

Experimental Method:

Prior to testing, the thermocouples, pressure transducers, ozone analyzer, and data acquisition instrumentation are checked to ensure they are functioning properly. The 2L vessel is opened and wiped down with acetone. A 10mm 40 gauge tinned copper wire is wrapped around the igniter electrodes. The vessel is sealed and checked for leaks through pressurizing the vessel. This is followed by a vacuum and pressure purging procedure with a diluent gas (N_2 or O_2) depending on the test conditions. The gas manifold and piping are vacuumed and pressure purged with the respective gas prior to addition into the vessel. The purging helps minimize trace contamination of other gases as well as to remove residual moisture.

By assuming that these gases behave ideally, the gas concentration is determined based on partial pressure addition. Prior to gas filling, the vessel is evacuated down to approximately 0.2 psia. The magnetic stirrer is turned on to provide mixing during the gas filling step. Each gas is added slowly to the desired concentration based on the partial pressure calculation. During addition, there is a slight temperature rise due to the compression of the gases; therefore, after each gas addition, the mixture is allowed to reach equilibrium. The gas manifold and piping are purged with the subsequent gas prior to being added to the mixture.

For the ozone tests, oxygen is fed into a corona discharge ozone generator. A potentiometer on the unit controls the power to the elements. Thus, by adjusting the oxygen flowrate through the generator and tuning the potentiometer, the precise ozone/oxygen ratio specified in the test matrix can be produced. The ozone concentration is measured with an in-line ozone analyzer that is placed on the outlet line of the vessel.

Early scoping tests performed to optimize the test setup indicated that if ozone was added to the test vessel while the vessel was under a vacuum, the ozone decomposed very rapidly, making it difficult to establish the desired test conditions. By feeding the ozone/oxygen mixture through the process vessel at atmospheric pressure, then monitoring the ozone concentration at the discharge, an accurate determination of the ozone concentration in the test vessel, just prior to the addition of hydrogen, may be made. The test vessel can then be evacuated just enough to add the prescribed volume of hydrogen for the test, minimizing loss of ozone.

Once the mixture has been prepared, the magnetic stirrer is turned off. The mixture is allowed to relax prior to ignition so that a quiescent mixture is tested rather than a turbulent mixture. The low pressure transducer valve is closed and the data collection is started. The mixture is manually ignited using the fuse wire providing a nominal 10 joules. The data acquisition records the pressure and temperature time traces in the vessel. A mixture is considered to be

flammable if the pressure rise after the ignition event is greater than or equal to 7% in accordance with ASTM E918. The procedure is repeated until there are a minimum of two demonstrations conducted at the lowest fuel concentration to be considered flammable and three at the highest fuel concentration considered non-flammable.

RESULTS

Hydrogen LFL

The lower flammable limit for the ignition tests of initially quiescent hydrogen-air mixtures was determined as 4.2 volume percent based on the ASTM 7% pressure rise criteria. A comparison of this result to data obtained by other researchers is summarized in Table II.

Table II: Hydrogen LFL in Air, this testing compared to others

Source	Hydrogen Concentration (vol. %)	Comments
LFL using 7% pressure rise criteria		
Present Work	4.2 ± 0.1	2-L vessel (L/D = 1)
Crowl and Jo [5]	5.7	20-L spherical vessel
Cashdollar et al. [6]	5.0 ± 0.5	8-L chamber
	6.0 ± 0.5	20-L chamber
	6.5 ± 0.5	120-L spherical vessel
LFL using a visual criterion		
Coward and Jones [1]	4.0	Flammability Tube

The experimentally measured LFL is in close agreement with the accepted lower flammable limit of 4 vol. % which was obtained through visual criterion [1]. Many other researchers have shown that it is difficult to obtain this value using the 7% pressure rise criteria. This has been explained through hydrogen's high diffusivity as compared to oxygen and nitrogen [6].

The majority of tests using the pressure rise criteria are performed with the ignition source in the center of the vessel. Central ignition is used for the determination of the explosion severity of flammable mixtures because it gives the maximum rate of pressure rise and the maximum overpressure. However, central ignition may not be useful when determining the limits of flammability. It has been shown that ignition source location has an impact on the flammability limits of methane [7]. As the location of the ignition source is lowered, a larger percentage of the combustible mixture participates in the reaction with minimal heat loss to the vessel wall. This results in a higher explosion overpressure, thereby widening the flammable region. The present work uses an ignition source placed approximately one-third from the bottom of the vessel.

Ozone LFL

The LFL of ozone in oxygen was determined as 8.4 volume percent. Previous studies on the flammability of ozone in oxygen are presented in Table III.

Table III: Ozone LFL in Oxygen, this testing compared to others

Source	Ozone Concentration (vol. %)	Comments
Present Work	8.4 ± 0.1	2-L vessel (L/D = 1)
Mizutani et al. [8]	10.5	1-L cylindrical vessel, Electric spark
Koike et al. [2]	10.0	1-L cylindrical vessel, 1 J electric spark
Cook et al. [9]	9.5 ± 0.5	10 cm i.d. glass bulb, 0.47 J electric spark

The present work reveals that the explosion limit of ozone in oxygen is consistent with previously reported values; however, it is lower than other literature data which can be attributed to the differences in the experimental method and procedure. The lower explosion limit obtained in this work is most likely a result of a combination of factors: the type of ignition source, location of the ignition source, and vessel size and geometry. In these tests, the ignition source energy was setup to give approximately 10J which is much greater than that used in previous work. Flammability limits are a function of ignition energy, thus, by increasing the strength of the ignition source, the flammable limits tend to widen [10]. There also tends to be some variation in the flammable limits which is influenced by the type of ignition source: a fuse wire as compared to an electric spark [11]. This may be an effect of the energy density provided by each type of ignition source and the amount of energy actually being transferred to the mixture. As discussed previously, the ignition source location may be playing a part in the lower value obtained.

The differences in the size and dimensions of the explosion vessels could have affected the lower flammable limit [11]. As the vessel size is increased, the heat losses to the wall become negligible. Through minimizing heat losses to the vessel wall, more heat is transferred to the combustion reaction, therefore, promoting flame propagation. This will result in a widening of the flammable region and combustion can occur at lower temperatures.

LFL of hydrogen in ozone/oxygen mixtures

The experimental results for the lower flammable limits of hydrogen in the ozone/oxygen concentrations defined in the test matrix are shown in Figure 3. The solid circles represent a flammable mixture and the open circles represent a non-flammable mixture.

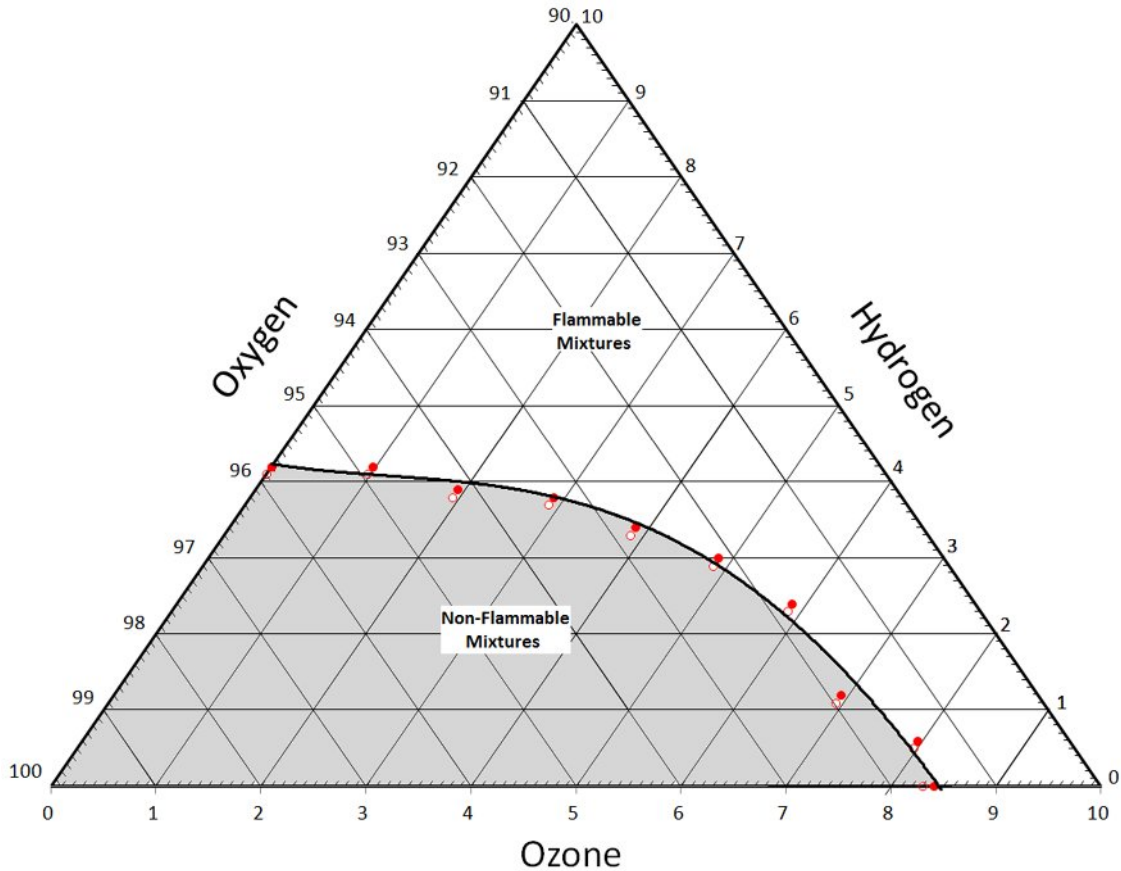

Figure 3: Flammability envelope for hydrogen/ozone/oxygen mixtures (all values are in volume percent)

The data show that the LFL of hydrogen decreases as the ozone concentration increases. This is a result of ozone behaving as a flammable gas; therefore, the flammable content of the mixture increases as the ozone concentration increases. Specifically, for example, Figure 3 indicates that a gas stream combination of 3% hydrogen, 4.8% ozone, and 92.2% oxygen ignites under the conditions established during the testing.

Typically, it is of interest to estimate the flammability limits of multi-component mixtures. In the absence of experimental data, estimation methods can be useful if the flammable limits of pure components are known. Le Chatelier [12] developed an empirical equation for predicting the flammable limits of fuel mixtures,

$$= \text{---}$$

where x_i is the mole fraction of the i^{th} component on a combustible basis and LFL_i is the lower flammable limit of the i^{th} component in volume percent. Mashuga and Crowl [13] have provided a derivation for this mixing rule using thermodynamics principles with the following assumptions:

1. The product heat capacities are constant

2. The number of moles of gas is constant
3. The combustion kinetics of the pure species are independent and unchanged by the presence of other combustible species
4. The adiabatic temperature rise at the flammability limit is the same for all species

A comparison of the LFL predictions to the experimentally determined LFL of hydrogen in various ozone-oxygen mixtures is shown in Figure 4. It was found that the LFL of hydrogen decreases as the ozone concentration in the mixture increases. This result is consistent with the values approximated through Le Chatelier's rule; however, the experimental results are higher than the predicted calculations. Previous studies have shown that Le Chatelier's rule provides close approximations for many simple hydrocarbons; however, it is less accurate for mixtures with hydrogen and generally not applicable for substances that undergo decomposition [14]. However, from a safety stand point, Le Chatelier's rule provides a conservative estimate of the LFL.

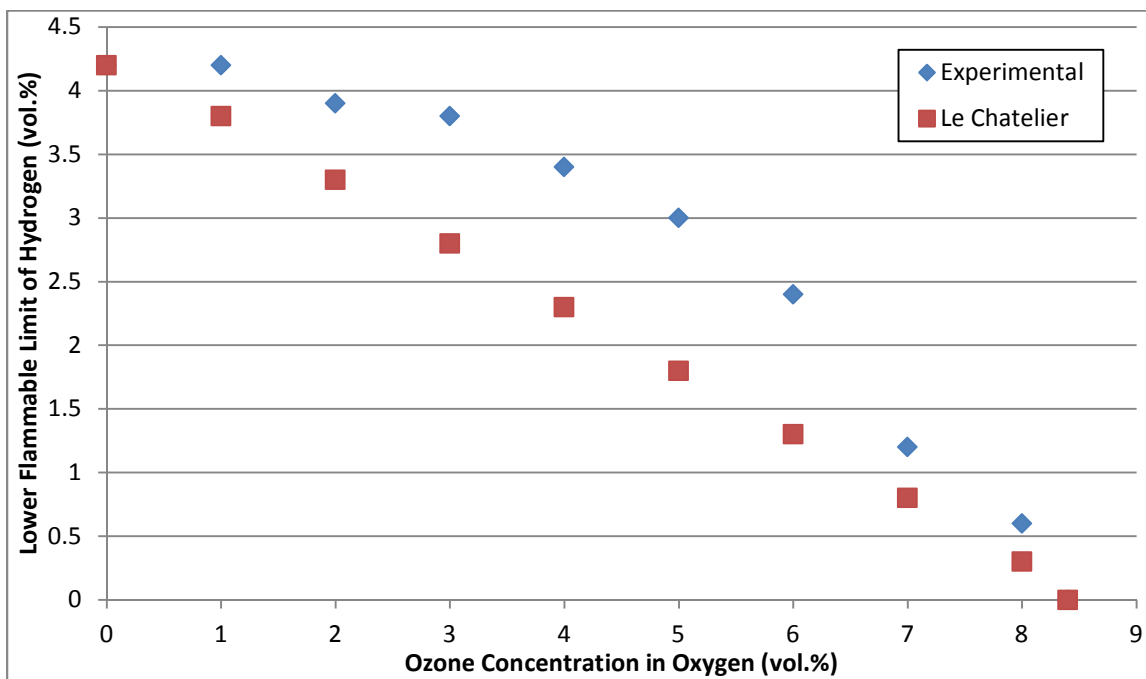

Figure 4: Lower flammable limit of hydrogen as a function of the ozone concentration

The difficulty in estimating the flammability limits of a hydrogen/ozone/oxygen mixture lies within the unpredictability of ozone. This unpredictability comes from the instability of ozone, which tends to readily decompose to form oxygen. Furthermore, there are many different reactions that could be taking part in these experiments: H_2-O_2 , O_3 decomposition, O_3-O_2 , and H_2-O_3 . The data seems to suggest that as the ozone concentration is increased, the reaction mechanism that takes precedence changes.

The deviation between the predicted and the experimental values may be two-fold. First, the reaction mechanism taking preference during the combustion reaction changes as the ozone concentration is increased. Secondly, the concentration of ozone participating in these reactions may be changing as well. Tests conducted on ozone decomposition in oxygen have

shown that only 5.3% of the ozone decomposes for a gas mixture containing 6.7 vol % ozone and as high as 90% decomposition when the ozone concentration was 11.2% in the mixture [9]. In any case, additional work is needed to fully understand the nature of these experiments.

In general, there are numerous factors that influence the flammable limits of a gas mixture: pressure, temperature, ignition source (type, strength, and location), vessel size and geometry, flame propagation, turbulence, being a partial list. For this reason, there are many different reported values pertaining to the flammable limits of specific mixtures as shown in the reported literature values given for comparison in the present work. Minor variances in the test setup and procedure can have a pronounced effect on the measured limits of flammability. The numerous influences on flame propagation can further provide some variability within the measured data. The measured pressure rise at a specific concentration is influenced by some of the following factors: the actual location where the mixture is ignited, homogeneity of the mixture, and how the flame propagates through the mixture. Though the influences affecting the flame propagation are not limited with the ones mentioned, it is enough to show that numerous considerations are needed in designing a test protocol as well as in data analysis. With proper consideration of these influences, lower values of the flammable limits were obtained in this work as a result of improvements in the testing methodology when compared with reported values from historical work.

Conclusions

The LFL of hydrogen in air was determined and is in good agreement with the literature data. Ozone-oxygen mixtures were found to be flammable at concentrations above 8.3 vol.% based on the ASTM E918 7% pressure rise criteria for flame propagation. This result is lower than previously reported values which can be explained through the variations in the test setup and procedure. It is believed that the lower values obtained in this work are a result of improvements of the test methodology. Tests performed with hydrogen in various concentrations of ozone in oxygen have shown that the LFL of hydrogen decreases as the concentration of ozone in the mixture increases.

Impact on Operation

This testing was designed to provide data under the conditions considered most optimal to produce deflagration. The geometry and materials of construction of the testing vessel; the location of the fuse wire; the magnitude of the supplied energy; the careful minimization of diluents and other contaminants; and meticulous procedural detail to maintain integrity of the ozone to the maximum extent practical, result in data that reflect not the expected process conditions, but those that enhance the possibility of flame propagation. For this reason, there is believed to be considerable conservatism in the indicated results. Per the vendor, the maximum possible ozone concentration producible by the planned ECC Ozone generator is 8 volume percent (the typical maximum operating setpoint concentration is 6.8 vol%), less than the 8.3 minimum volume % concentration shown to be flammable in a 99.999% pure O₂ environment at the optimally conservative conditions established in this testing. Further, the feed to the ECC ozone generator is only 87% oxygen, the remainder, water vapor and nitrogen, both powerful diluents. It is, thus, believed not credible that deflagration can occur at this maximum feed

concentration condition. In addition, once the ozone stream contacts the waste stream, the many simultaneous oxidizing reactions will rapidly decompose available ozone to well below flammable levels. Further, because the radiolytically generated hydrogen quantity is negligible compared to the supplied ozone/oxygen stream (0.0004 moles per minute H₂ vs 76 moles per minute ozone/oxygen), even the total H₂/O₃ mixture, without crediting decomposition reactions, does not approach flammable concentrations. Finally, even at the “end” of the ECC batch cycle, when most of the metal oxalates have been decomposed, testing has indicated that the ozone concentration in the vapor space of the ECC process vessel reaches a concentration of no more than 3 vol%, remaining well below concentrations of concern.

The major issue for the ECC operation established by this testing is the impact of the data when applied to off normal conditions. While it is possible to discontinue ozone addition to the reaction vessel at any time, the radiolytic hydrogen generation rate continues, varying slightly as ambient pressures and temperatures change. Relative to the data generated and analyzed in this testing, the ECC hazards analysis team will re-evaluate off normal conditions (e.g. those during which process exhaust ventilation is lost) such that issues involving mixtures of hydrogen and ozone in the vapor space can be appropriately controlled.

Future Testing

Future work will include further defining the LFL of hydrogen in various ozone concentrations at elevated temperature and pressure conditions. We plan to evaluate how ozone may affect the detonations limits of hydrogen.

REFERENCES

1. Coward, H. F., & Jones, G. W. (1952). *Limits of Flammability of Gases and Vapors*. BuMines, 503.
2. Koike, K., Nifuku, M., Izumi, K., Nakamura, S., Fujiwara, S., & Horiguchi, S. (2005). Explosion properties of highly concentrated ozone gas. *Journal of Loss Prevention in the Process Industries* , 18, 465-468.
3. ASTM. (2005). ASTM E 918-83 Standard Practice for Determining Limits of Flammability of Chemicals at Elevated Temperature and Pressure. Philadelphia, PA: American Society for Testing and Materials.
4. Mashuga, C. V. (1999). *Determination of the Combustion Behavior for Pure Components and Mixtures using a 20-Liter Sphere*. Phd Thesis. Michigan Technological University. Ann Arbor: UMI Company.
5. Crawl, D. A., & Jo, Y.-d. (2009). A Method for Determining the Flammable Limits of Gases in a Spherical Vessel. *Process Safety Progress* , 28 (3), 227-236.
6. Cashdollar, K. L., Zlochower, I. A., Green, G. M., Thomas, R. A., & Hertzberg, M. (2000). Flammability of methane, propane, and hydrogen gases. *Journal of Loss Prevention in the Process Industries* , 13, 327-340.

7. Van den Schoor, F., Norman, F., & Verplaetsen, F. (2006). Influence of the ignition source location on the determination of the explosion pressure at elevated initial pressure. *Journal of Loss Prevention in the Process Industries* , 459-462.
8. Mizutani, T., Matsui, H., Sanui, H., & Yonekura, M. (2001). Decomposing detonation and deflagration properties of ozone/oxygen mixtures. *Journal of Loss Prevention in the Process Industries* , 14, 559-565.
9. Cook, G. A., Spadinger, E., Kiffer, A. D., & Klumpp, C. V. (1956). Explosion Limits of Ozone-Oxygen Mixtures. *Industrial and Engineering Chemistry* , 48 (4), 736-741.
10. Bartknecht, W. (1981). *Explosions, Course Prevention Protection*. New York: Springer-Verlag.
11. EU-Project SAFEKINEX. Report on the experimental factors influencing explosion indices determination. Programme "Energy, Environment and Sustainable Development", Contract No. EVG1-CT-2002-00072, 2003-2006
12. Le Chatelier, H. (1891). Note on the Determination of Firedamp by Flammability Limits. *Ann. Mines* , 19, 388-395.
13. Mashuga, C. V., & Crowl, D. A. (2000). Derivation of Le Chatelier's Mixing Rule for Flammable Limits. *Process Safety Progress* , 19 (2), 112-117.
14. Babrauskas, V. (2003). *Ignition Handbook*. Issaquah: Fire Science Publishers.